

SENSORS WITH CONNECTION HEADS

Configuration Code GP04 Spring-Loaded MgO Thermocouple/Thermowell Assemblies with General-Purpose Connection Heads

Spring-Loaded MgO Thermocouple/Thermowell Assemblies with General-Purpose Connection Heads are designed for use with various thermowell types. Complete assemblies can be ordered by selecting the MgO assembly below, the thermowell from the thermowell section of this catalog, and a temperature transmitter from the back of this section. Assemblies without a thermowell can be ordered by selecting the sensor assembly from this page and inserting the "S" length in table 2-0. These sensors are supplied with a 316 stainless steel sheath and as standard limits of error.

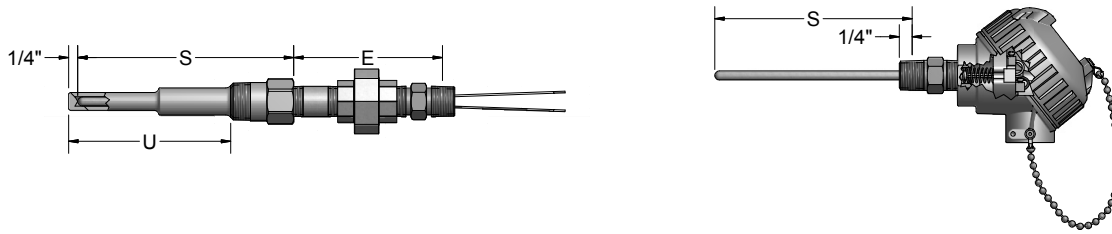

ORDER CODES

Example Order Number: **J 48 U** - **SL** - **8PU4 31, T-**

1-0 1-1 1-2 2-0 3-0 4-0 4-1 4-2

Select Thermowell Part # or Insert 3 Digit Length Code Select Type and Range from back of section

1-0 Thermocouple Types

CODE		
SINGLE	DUPLEX	TRIPLEX
E	EE	-
J	JJ	JJJ
K	KK	KKK
T	TT	-

1-1 Sheath Diameters

CODE	DIAMETERS (inches) 316 SS
38	3/16
48	1/4

1-2 Measuring Junction

CODE	DESCRIPTION
G	Grounded junction
U	Ungrounded junction

2-0

Select thermowell part number from Thermowell Section, or specify 3 digit "S" length in inches if no thermowell is required.

3-0 Element Options

CODE	DESCRIPTION
SL ^[1]	Spring-loaded element
SC	Self-contained spring-loaded element
SN	Self-contained spring-loaded element with Buna-N oil seal 121°C [250°F] 100 PSI Max.

[1] Not available with option 35T, 36T, or 37T

HART® is a registered trademark of HART Communication Foundation.

4-0 Head Mounting Fittings

CODE	DESCRIPTION
STEEL FITTINGS	
6HN	1/2" x 1/2" NPT hex nipple 1" "E" length
6PN_	1/2" NPT pipe nipple (specify "E" length in inches)
6PU_ ^[1]	1/2" NPT union/nipple (specify "E" length in inches)
316 SS FITTINGS	
8HN	1/2" x 1/2" NPT hex nipple 1" "E" length
8PN_	1/2" NPT pipe nipple (specify "E" length in inches)
8PU_ ^[1]	1/2" NPT union/nipple (specify "E" length in inches)

[1] 4" Minimum length required

4-1 Head and Sheath Terminations

CODE	DESCRIPTION
22	3" Individual fluoropolymer leads with terminal pins
31	Aluminum screw-cover head
34	Cast iron screw-cover head
35T-642A	(4 to 20) mA HART® Field Transmitter with aluminum general-purpose housing
36T82-D10	(4 to 20) mA dual input HART® transmitter with digital display and general-purpose aluminum housing with glass lid
37T-662A	(4 to 20) mA HART® dual cavity field temperature transmitter with general-purpose aluminum housing
49	Flip-top aluminum head
63	White polypropylene screw-cover head
91	316 L stainless steel screw-cover head

4-2 Options

W ^[1]	Epoxy Coating
GS	Ground screw
I	Stainless tag
NB	1/2" NPT nylon conduit reducer bushing
SB	1/2" NPT conduit reducer bushing
T-441	(4 to 20) mA isolated head-mounted transmitter
T-442	(4 to 20) mA isolated HART® head-mounted transmitter
T82-00	(4 to 20) mA dual input HART® head-mounted transmitter

See transmitter ordering information in back of section.

[1] Available with option 31 only.



SENSORS WITH CONNECTION HEADS

Configuration Code GP04 Spring-Loaded MgO Thermocouple/Thermowell Assemblies with Explosion-Proof Connection Heads

Spring-Loaded MgO Thermocouple/Thermowell Assemblies with Explosion-Proof Connection Heads are designed for use with various thermowell types. Complete assemblies can be ordered by selecting the MgO assembly below, the thermowell from the thermowell section of the catalog, and a temperature transmitter from the back of this section. Assemblies without a thermowell can be ordered by selecting the sensor assembly from this page and inserting the "S" length in table 2-0. These sensors are supplied with a 316 stainless steel sheath and as standard limits or error.

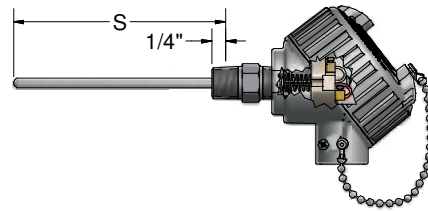
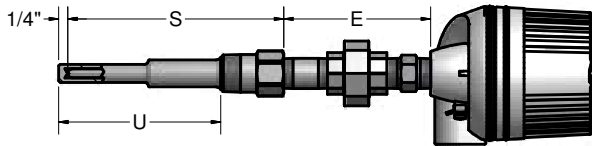

ORDER CODES

Example Order Number:

1-0 1-1 1-2 2-0 3-0 4-0 4-1 4-2
J 48 U - Select Thermowell Part # or Insert 3 Digit Length Code - **SL** - **8XU4 93, T** - Select Type and Range from back of section

1-0 Thermocouple Types

CODE		
SINGLE	DUPLEX	TRIPLEX
E	EE	-
J	JJ	JJJ
K	KK	KKK
T	TT	-

1-1 Sheath Diameters

CODE	DIAMETERS (inches) 316 SS
38	3/16
48	1/4

1-2 Measuring Junction

CODE	DESCRIPTION
G	Grounded junction
U	Ungrounded junction

2-0

Select thermowell part number from Thermowell Section, or specify 3 digit "S" length in inches if no thermowell is required.

3-0 Element Options

CODE	DESCRIPTION
SL ^[1]	Spring-loaded element
SC	Self-contained spring-loaded element
SN	Self-contained spring-loaded element with Buna-N oil seal 121°C [250°F] 100 PSI Max.

[1] Not available with option 75T, 76T, or 77T

4-0 Head Mounting Fittings

CODE	DESCRIPTION
STEEL FITTINGS	
6HN	1/2" x 1/2" NPT hex nipple 1" "E" length
6PN_	1/2" NPT pipe nipple (specify "E" length in inches)
6XU_ ^[1]	1/2" NPT union/nipple (specify "E" length in inches)
316 SS FITTINGS	
8HN	1/2" x 1/2" NPT hex nipple 1" "E" length
8PN_	1/2" NPT pipe nipple (specify "E" length in inches)
8XU_ ^[1]	1/2" NPT union/nipple (specify "E" length in inches)
[1] 3 1/2" Minimum length required	

4-1 Head Terminations

CODE	DESCRIPTION
74	Dual conduit DIN form B aluminum explosion-proof/flame-proof head, NEC, IEC, Atex approved
75T-642C	(4 to 20) mA HART® field transmitter with aluminum explosion-proof housing
76T82-D10	(4 to 20) mA dual input HART® Field Transmitter with digital display and explosion-proof aluminum housing
77T-662C	(4 to 20) mA HART® Field Transmitter with dual cavity explosion-proof aluminum housing
93	Aluminum explosion-proof/flame-proof head, NEC, IEC, Atex approved
94	316L stainless steel explosion-proof/flame-proof head, NEC, IEC, Atex approved

4-2 Options

SB	1/2" NPT conduit reducer bushing
I	Stainless tag
T-441	(4 to 20) mA isolated head-mounted transmitter
T-442	(4 to 20) mA isolated HART® head-mounted transmitter
T82-00	(4 to 20) mA Dual input, isolated HART® head-mounted transmitter

See transmitter ordering information in back of section.

HART® is a registered trademark of HART Communication Foundation.



The drilled thermowells listed below are those most commonly found in process applications. Other types and styles are listed later in this section. The thermowells listed below are available as separate component wells and can be ordered by the code numbers listed below. They can also be ordered as a part of a complete sensor assembly. Consult factory for wells with different mounting threads, lengths, and materials.

STANDARD-DUTY WELLS

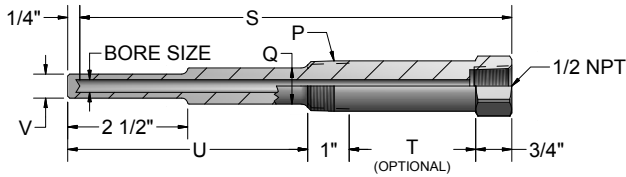

STRAIGHT-SHANK, SOCKET-WELD

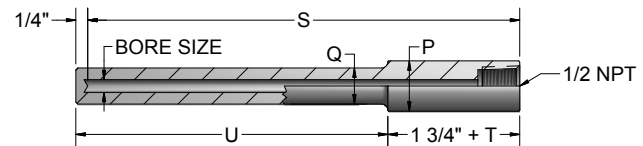

HEAVY-DUTY WELLS

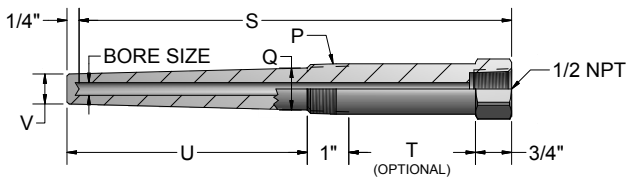

WELD-IN WELLS

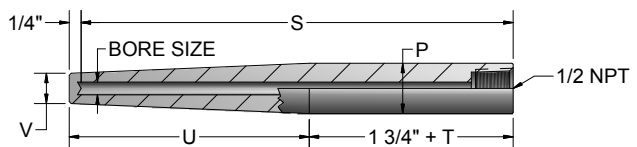

ORDER CODES

Example Order Number:

1-0 1-1 1-2 1-3 1-4 1-5 1-6
S 4 D 06 08 T2 S

1-0 Well Type

CODE	DESCRIPTION
S	Standard-duty threaded (NPT)
H	Heavy-duty threaded (NPT)
SW	Straight-shank, socket-weld
WI	Weld-in

1-1 Bore Size

CODE	DESCRIPTION
4	0.260 Dia. Bore

1-2 Pipe Size "P"

CODE	DESCRIPTION
C	1/2" Pipe ^[1]
D	3/4" Pipe
E	1" Pipe

[1] Only available with well type S or H

1-3 Length Dimensions (inches)

CODE	"S" DIMENSIONS	"U" DIMENSIONS	
		NO LAG	WITH STANDARD LAG
04	4	2(1/2)	N/A
06	6	4(1/2)	2(1/2)
09	9	7(1/2)	4(1/2)
12	12	10(1/2)	7(1/2)
15	15	13(1/2)	10(1/2)
18	18	16(1/2)	13(1/2)
24	24	22(1/2)	19(1/2)

1-6 Well Options

CODE	DESCRIPTION
C8	316 stainless steel well cap and chain
C22	Brass well cap and chain
S	Customer specified part number marked on the thermowell - (10 digit maximum)

1-5 Optional "T" Lag Dimension

CODE	DESCRIPTION
Leave blank if No Lag is required	
T2	2" Lag standard on 6" well
T3	3" Lag standard on 9, 12, 15, 18, 24" wells
T__	Special Lag specify "T" dimension in inches

1-4 Material

CODE	DESCRIPTION
08	316 stainless steel
09	304 stainless steel

The flanged thermowells described on this page are those commonly found in most process applications. These wells are supplied as standard- or heavy-duty with raised-faced flanges. Other types and styles are listed later in this section. Consult factory for wells with different flange sides, lengths, and materials.

FLANGED THERMOWELLS

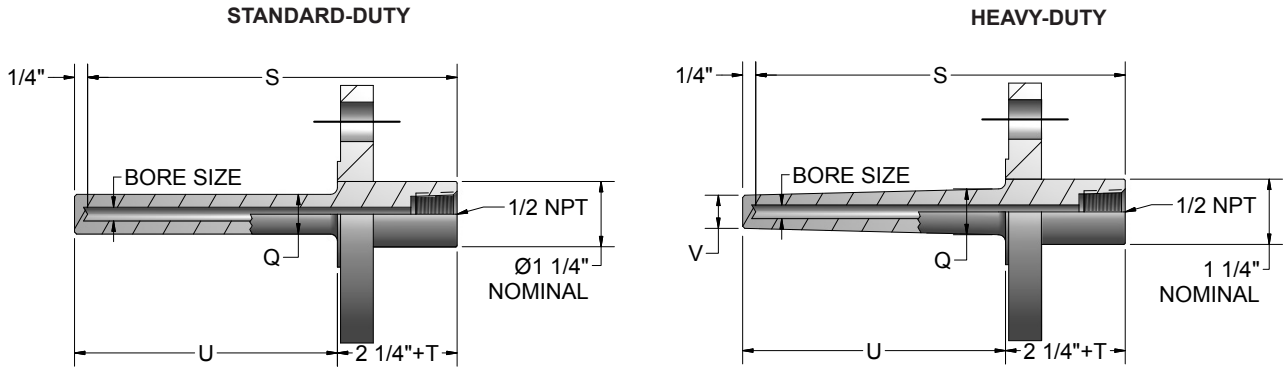

ORDER CODES

Example Order Number:

1-0 1-1 1-2 1-3 1-4 1-5 1-6 1-7 1-8
SF 4 15 R 3 12 08 T2 C8

1-0 Well Type

CODE	DESCRIPTION
SF	Standard-duty flanged
HF	Heavy-duty flanged

1-1 Bore Size

CODE	DESCRIPTION
4	0.260 Bore

1-2 Flange Size

CODE	DESCRIPTION
10	1"
15	1 1/2"
20	2"

1-3 Flange Type

CODE	DESCRIPTION
R	Raised face

1-4 Pressure Rating

CODE	DESCRIPTION
1	150 class
3	300 class

1-8 Well Options

CODE	DESCRIPTION
C8	316 stainless steel well cap and chain
C22	Brass well cap and chain
S	Customer specified part number marked on thermowell (10 digit maximum)

1-7 Optional "T" Lag Dimension

CODE	DESCRIPTION
	Leave blank if no lag is required
T__	Specify "T" dimension in inches

1-6 Well Material

CODE	DESCRIPTION
08	316 Stainless steel
09	304 Stainless steel

1-5 Well Length (inches)

CODE	DESCRIPTION	
	"S" DIMENSION	"U" DIMENSION
06	6	4
09	9	7
12	12	10
15	15	13
18	18	16
24	24	22